

version .0

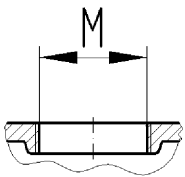

version .1

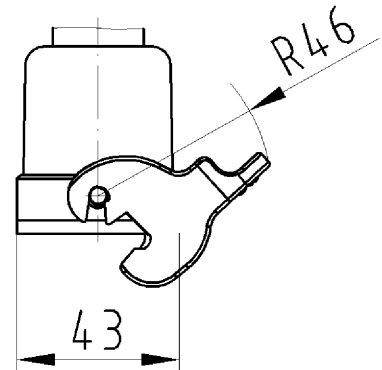
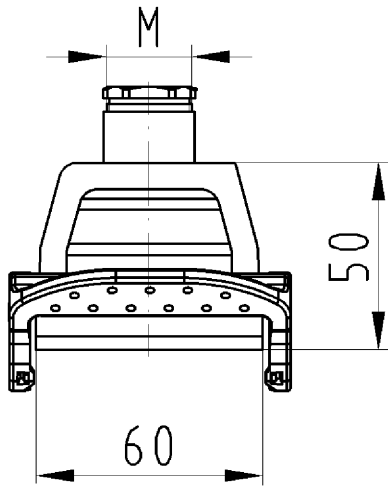
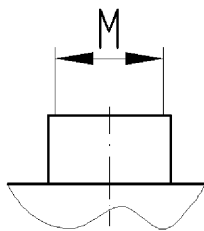

version .2

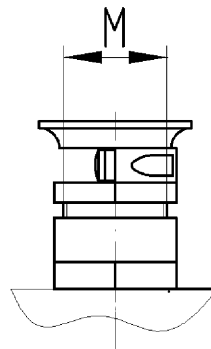

version .3

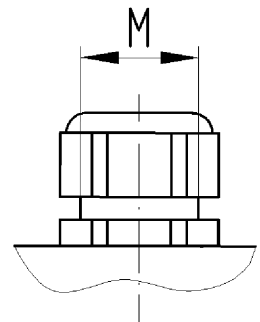

version .5

IP 65

Gehäuseoberteil
70.372.0635.0

Zeichnungsnummer
70.372.0635.010W
Gehäuseoberteil

15.11.2007
Schreiber Patrick
M 1:2